



SMITHS FALLS

RISE AT THE FALLS



STOREFRONT & SIGNAGE
GUIDEBOOK

Town of Smiths Falls, Ontario

100% COMPLETE

PREPARED BY

IRON  IVORY

TABLE OF CONTENTS

01 Signage	5
SIGNAGE TYPES	7
SIGNAGE OPPORTUNITIES	8-9
PRIMARY BAND SIGN	10-11
WINDOW SIGNAGE	12-13
WINDOW DECAL STEP BY STEP	14-15
BAND SIGNAGE	16-17
02 Storefront	19
STOREFRONT LEVELS	20-23
LEVEL 1 + LEVEL 2	24-25
LEVEL 1 + 2 - STEP BY STEP	26-27
LEVEL 3 TYPE A	28-29
LEVEL 3 TYPE B	30-31
LEVEL 3 - STEP BY STEP	32-33
03 Specifications	35
COLOR PALETTES	36-37
PRE-APPROVED COLOR PALETTES	38-41
PAINT SPECIFICATIONS	42-45
Appendix	SEPARATE DOCUMENT



SIGNAGE



PRIMARY BAND SIGN

The primary band sign above the storefront will be the largest and most prominent signage.

WINDOW SIGNAGE

Window decals store hours, and taglines will be located directly on storefront glazing and will be specific to your branding style.

NON-ILLUMINATED BLADE SIGN

Blade signs that project into the sidewalk will attract passers-by and animate the sidewalk.

SIGNAGE OPPORTUNITIES

01 | Primary Band Sign

BUSINESS NAME

EST. DATE

02 | Window Signage

LOGO DECAL

TAGLINE

STORE HOURS

03 | Blade Sign

BUSINESS NAME

LOGO

EST. DATE

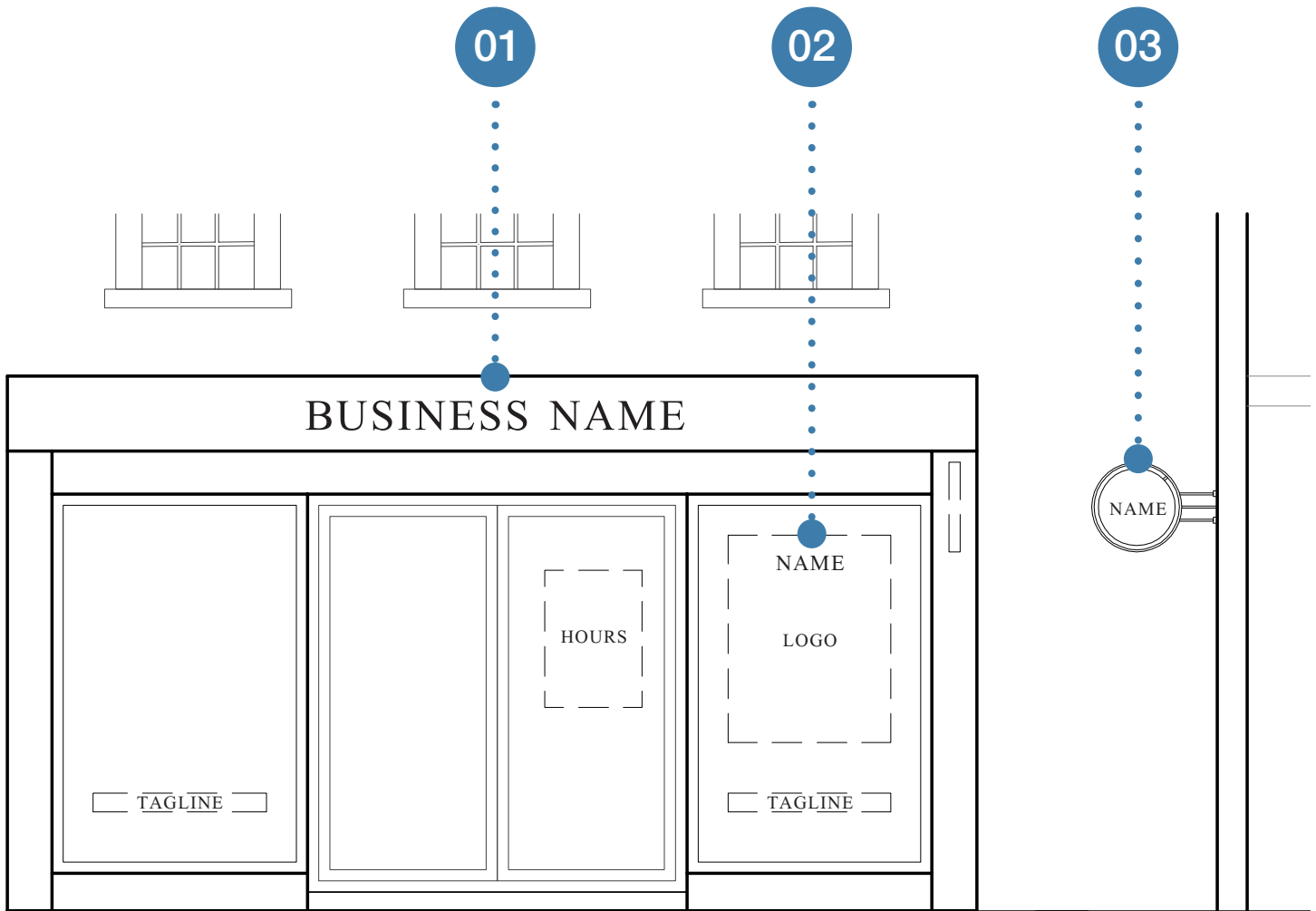

NOTES

Please refer to Sign Bylaw for specific details on signage provisions in downtown core.

All owner/tenant supplied signage to be reviewed and approved by the Town of Smiths Falls Planning Department by contacting: mremmig@smithsfalls.ca

PRIMARY BAND SIGN

Primary signs are individual letters that are lit from the bottom up or top down and are installed directly to the storefront upper band or existing facade. Store signage is for the purpose of identification and should be limited to the trade name.

RECOMMENDATIONS

ALIGNMENT	WHERE POSSIBLE, BACK BOARD & BAND SIGN SHALL ALIGN AND MATCH DIMENSION OF ADJACENT BUILDING.
MAX. TEXT SIZE	TEXT SHALL BE NO GREATER THAN 12-16" IN HEIGHT
REQ. OFFSETS	TEXT SHALL BE SIZED TO MAINTAIN A MINIMUM DISTANCE OF 1 TO 3 INCHES FROM BAND BORDER
PROJECTION	TEXT SHALL PROJECT NO MORE THAN 3 INCHES FROM BAND SURFACE
FONT	VENDOR TO PROPOSE DESIRED FONT FOR APPROVAL
ILLUMINATION	BAND SIGN SHALL NOT BE ILLUMINATED FROM WITHIN
MATERIALS	SIGNAGE TEXT SHALL BE FROM APPROVED COLOR PALETTE OR APPROVED METAL FINISH
SIGNAGE BACK BOARD	ADDITION OF SIGNAGE BACK BOARDS BETWEEN PIERS IS ENCOURAGED

EXAMPLES



RAISED METAL LETTERING



PAINTED DIRECTLY ONTO EXTERIOR WALL

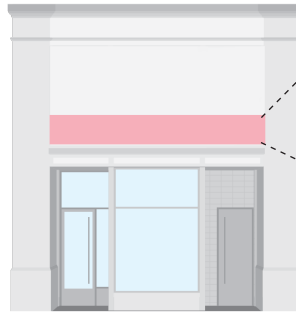

ADD SIGNAGE BACK BOARD BETWEEN PIERS

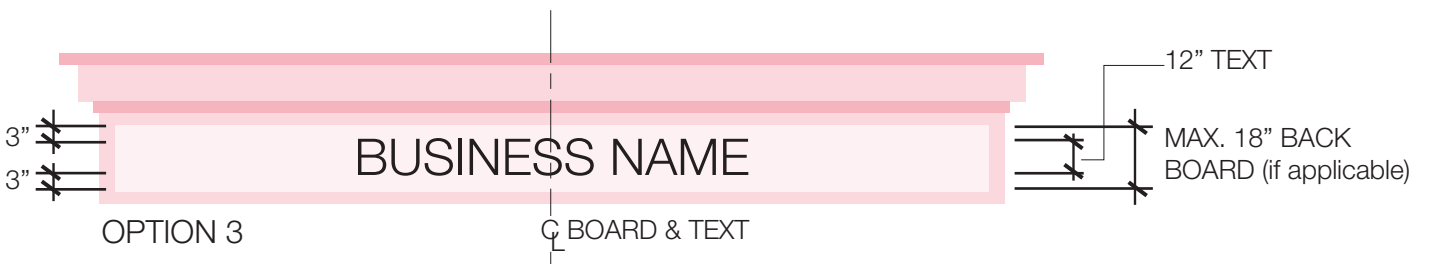
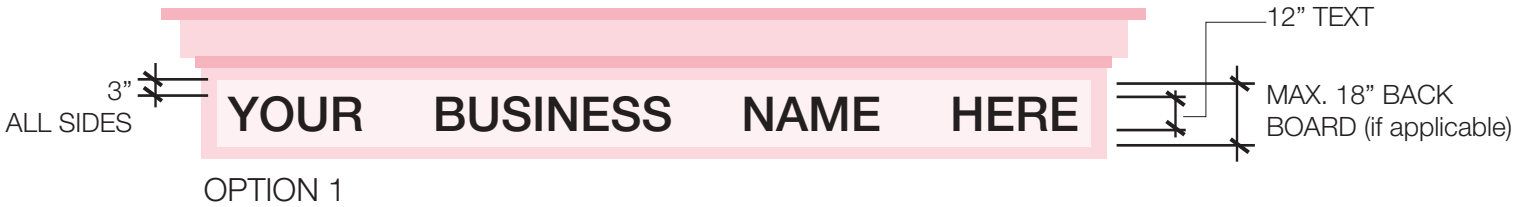

WINDOW SIGNAGE

Window signage can be used for the brand to express individuality and creativity. Window decals must be applied to the interior side of the glass. Window signage can be used for artwork, brand logos, and taglines. All doors are recommended to have store hours of operation posted using window decals.

RECOMMENDATIONS	
LOCATION	WINDOW SIGNAGE SHALL BE LIMITED TO THE SIGNAGE ZONE IN DASHED LINE [SEE DRAWING]
MAX. TEXT SIZE	TEXT HEIGHT SHALL BE NO GREATER THAN 1 FOOT
REQ. OFFSETS	TEXT SHALL BE SIZED TO MAINTAIN A MINIMUM DISTANCE OF 8 INCHES FROM WINDOW BORDER
APPLICATION	GRAPHICS SHALL BE APPLIED ON THE INTERIOR SIDE OF THE WINDOW
TRANSPARENCY	WINDOW SIGNAGE SHALL BE MINIMUM 70% TRANSPARENT
MATERIALS	WHITE SILKSCREEN, VINYL, OR HAND PAINTED GRAPHICS BE IMPLEMENTED. WASHABLE (TEMPORARY) WINDOW DECALS ARE PERMITTED
STORE HOURS	STORE HOURS ARE RECOMMENDED FOR ALL APPLICANTS

EXAMPLES



NAME AND TAGLINE
DECAL



NAME AND LOGO
DECAL



STORE HOURS WITH
BUSINESS INFO



HAND PAINTED

• TAGLINE PERMITTED WITHIN
• BOTTOM 25% OF WINDOW
• BOTH SIDES.

• STORE HOURS ARE RECOMMENDED
• FOR ALL BUSINESSES

• TRADE NAME SHALL BE
• LOCATED WITHIN TOP 25% OF
• WINDOW

• IF INCLUDED, LOGO SHALL BE
• CENTERED ON WINDOW

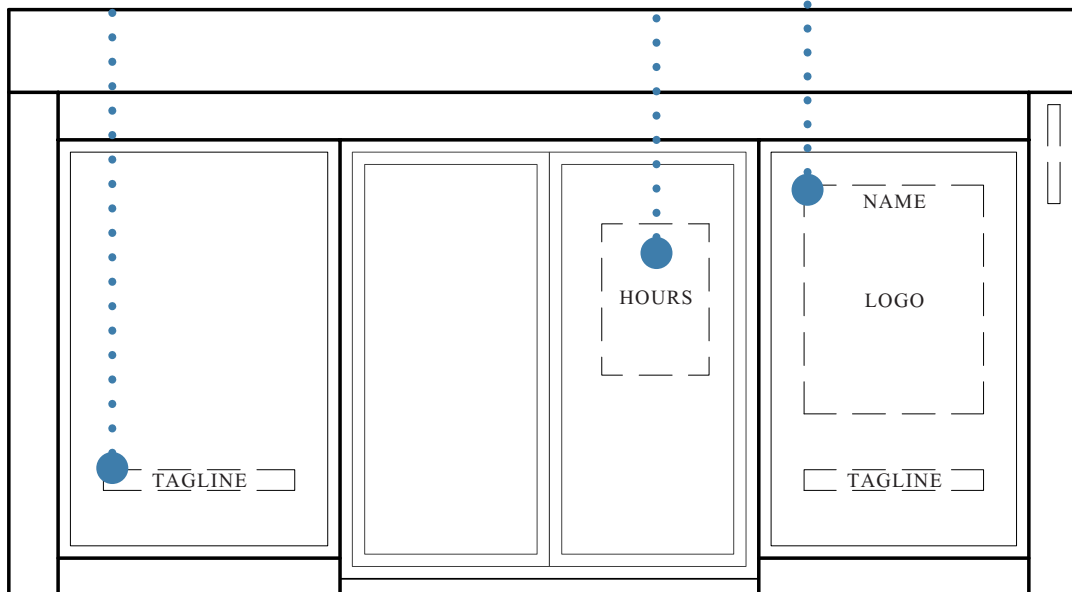

WINDOW DECAL STEP BY STEP

01

SELECT LEFT OR RIGHT GLASS PANEL

Select one glass panel of your choosing for the decal location.

02

VERIFY ALLOWABLE AREA FOR DECAL & TAGLINE

Measure 8" from the glass frame on all four sides. Your decal can be located anywhere within this space.

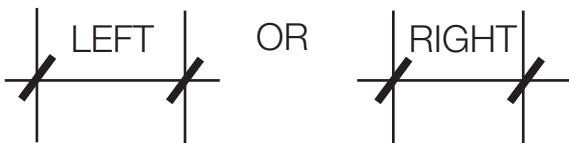
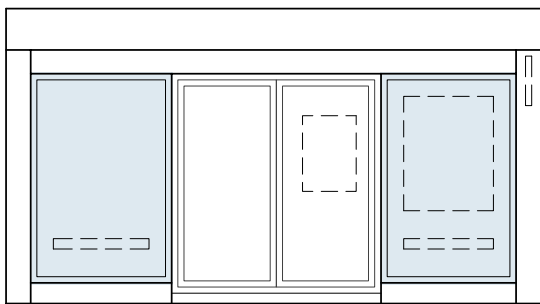

A tagline can also be located on the opposite panel.

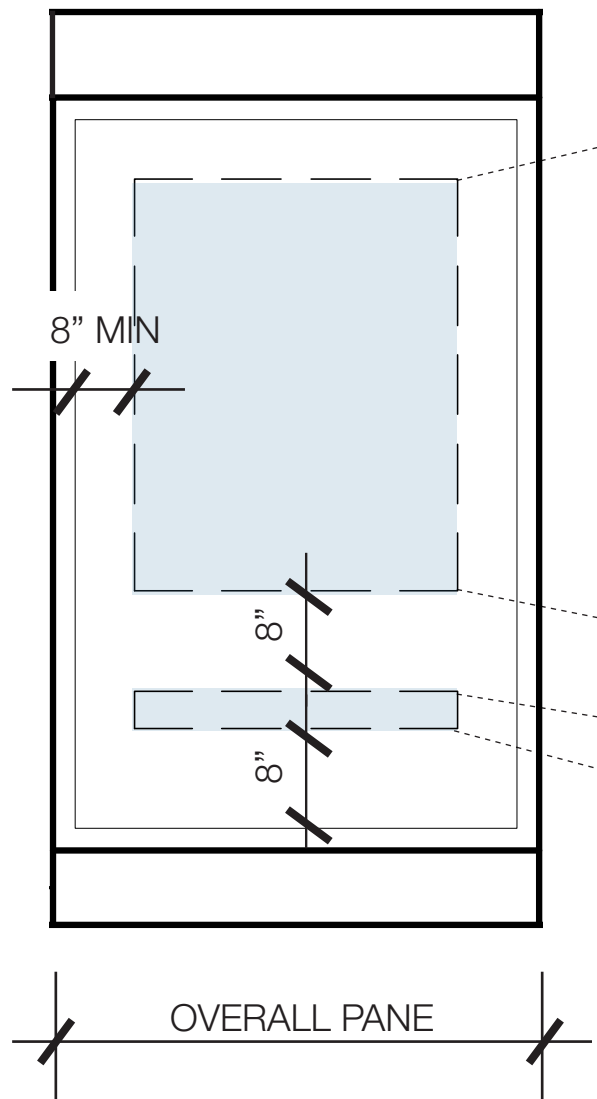

Shown in black for clarity. Decal must be white.

DESIGN YOUR DECAL

Your decal can include your business name, logo, or an artistic design. Decal must be white, and must not take up more than 30% of your allowable area, 70% must remain clear.

EXAMPLE 1

**RESTAURANT
NAME**



Est. 1936

INFORMATION INCLUDED:

BUSINESS NAME
BUSINESS LOGO
ESTABLISHED YEAR

Decal is approx. 20% of allowable area.

EXAMPLE 2

**RESTAURANT
NAME**

Est. 1936

Your neighborhood eatery

INFORMATION INCLUDED:

LOGO / BUSINESS NAME
ESTABLISHED YEAR
TAGLINE

Decal is approx. 25% of allowable area.

BLADE SIGNAGE

Projecting blade signs are recommended for all new signage applications. Blade signs may be located on the storefront, facade or within the upper storefront band. All clearances and projection limits must be strictly adhered to. Internally illuminated blade signs are permitted. All blades signs should be double sided for optimal viewing by two-way pedestrian traffic.

RECOMMENDATIONS	
LOCATION	BLADE SIGN SHALL BE RIGHT OR LEFT JUSTIFIED ON FULL BUILDING WIDTH
SHAPE	BLADE SIGN SHALL BE CIRCULAR IN SHAPE
MOUNTING HT.	BOTTOM OF BLADE SIGN SHALL BE NO LOWER THAN 8.5 FEET ABOVE FINISHED SIDEWALK
PROJECTION	BLADE SIGN SHALL PROJECT NO MORE THAN 39 INCHES FROM FACE OF BUILDING
ILLUMINATION	INTERNALLY ILLUMINATED SIGNS ARE NOT PERMITTED
MAX. TEX SIZE	TEXT SIZE AND LOGO SHALL BE LIMITED TO 75% OF OVERALL BLADE SIGN HEIGHT
MATERIALS	METAL AND ACRYLIC BLADE SIGN SHALL ADHERE TO APPROVED COLOR PALETTES

DETAILS



TRADE NAME AND BUSINESS INFO



24" OR 30" CIRCULAR BLADE SIGN

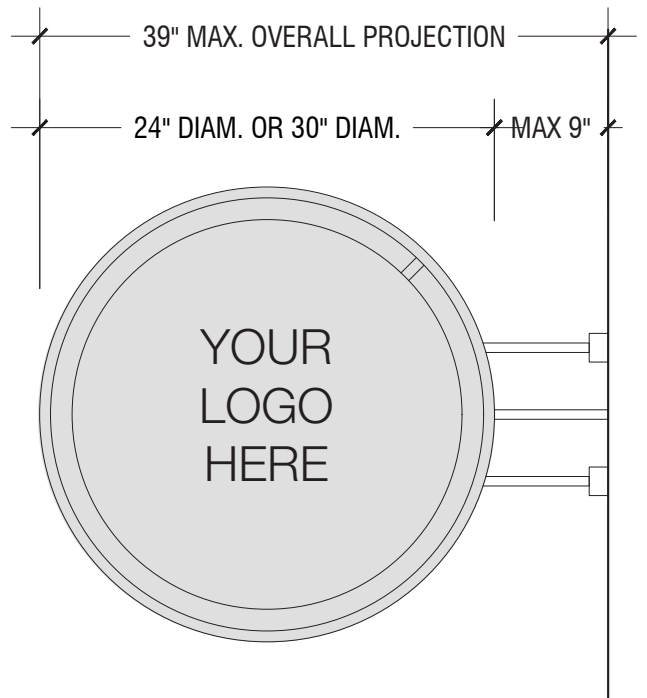
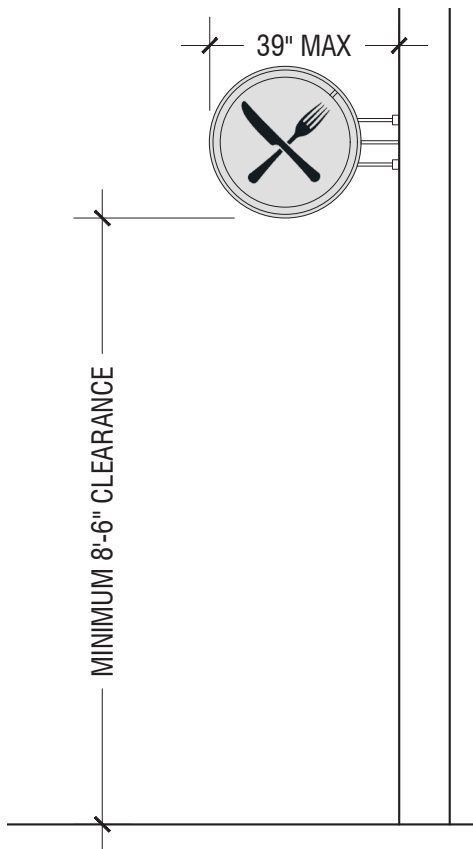



STOREFRONT



LEVEL 1 FACADE REFRESH

Fresh paint finishes at the storefront level will draw the eye down to the street level and create a focal point.

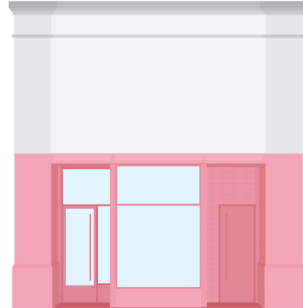

LEVEL 2 FACADE REFRESH

Complete paint finish on the full facade will give the entire building a modern spruce and dramatic backdrop for new signage.

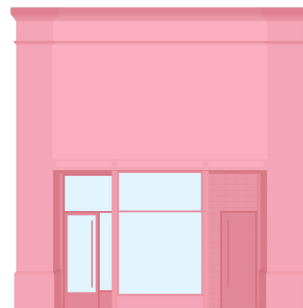



LEVEL 3 A FACADE RESTORATION

Storefront replacement with heritage style in mind, and historical detailing will provide a nod to the past.



LEVEL 3 B FACADE REDESIGN

Storefront replacement with modern details and a minimal style will elevate the facade with a contemporary feel.



LEVEL 1

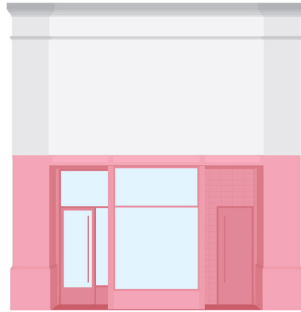

Level 1 storefront refresh should be employed as a cost-effective option that will have dramatic impact. This includes painting or re-finishing existing facades and storefronts at the first floor only.

LEVEL 2



Level 2 storefront refresh should be employed as a mid-level cost option that will improve the storefront and upper façade level. This includes re-painting or re-finishing existing facades and storefronts from first floor to the top level.

LEVEL 1 - EXAMPLES

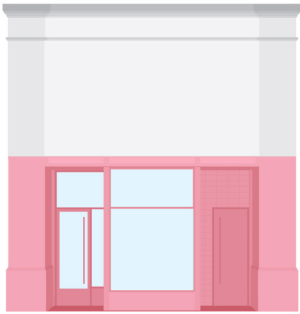

PAINT EXISTING
STOREFRONT
LEVEL



SELECT PAINT FROM
APPROVED LIST

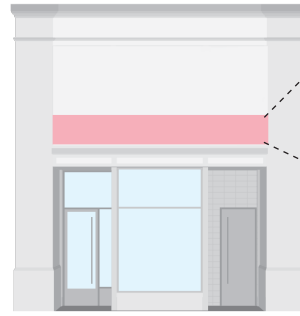

ADD SIGNAGE BACK
BOARD BETWEEN
PIERS



LEVEL 2 - EXAMPLES

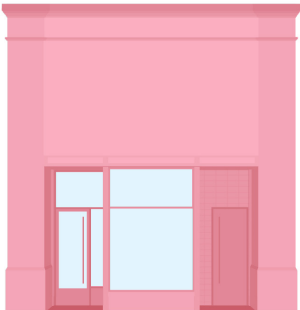

PAINT EXISTING
FACADE &
STOREFRONTS



REPLACE UPPER
WINDOWS



ADD CORNICE

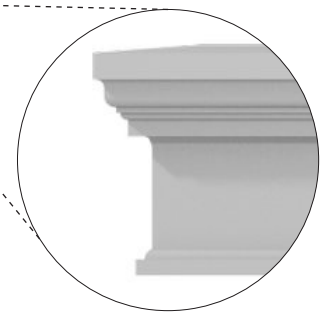

Refer to Specification's Chapter
for the full colour options.

LEVEL 1 + 2



RECOMMENDATIONS

EVALUATION	EVALUATION MUST BE COMPLETED BY PROFESSIONAL AND SUBMITTED TO CITY.
COLORS	PROPOSED COLORS MUST BE SELECTED FROM APPROVED LIST.
SUBSTRATE	SUBSTRATE PREPARATION MUST CONFORM TO BASIS OF DESIGN SPECIFICATIONS.
PRODUCTS	PAINT PRODUCTS MUST BE THE BASIS OF DESIGN OR AN APPROVED EQUAL, SELECTED BASED ON SUBSTRATE TYPE.
APPLICATION	FINISH APPLICATION MUST CONFORM TO BASIS OF DESIGN CRITERIA AND SPECIFICATIONS.
CORNICES	ADDITION OF CORNICES IS ENCOURAGED FOR A VISUAL BREAK BETWEEN EXISTING UPPER FINISHES AND NEW LOWER FINISHES.

STEP BY STEP



EVALUATE EXISTING SUBSTRATE

A professional must evaluate the existing substrate for any repairs that should be completed prior to application of new finishes. For example, failing mortar joints, wood rot, water leakage, substantial metal rust, general damages.



SUBMIT DRAWING OF PROPOSED WORK / COLOR PALETTE

Submit a drawing and application of your proposed scope of work and proposed color palette for the facade re-finishing and any new signage elements for approval by city authorities.



PREP SUBSTRATE - REFER TO APPENDIX

Substrate must be properly cleaned and prepared for proper adherence of new finishes. For example, clean or pressure wash to remove loose particles, etch metal surfaces for adherence, remove surface irregularities or sand existing coatings.



APPLY FINISHES

Purchase paint based on basis of design and appropriate substrate material. Application of all finishes should follow basis of design guidelines and specifications. Public space must be properly protected during and after work

LEVEL 3 Type A

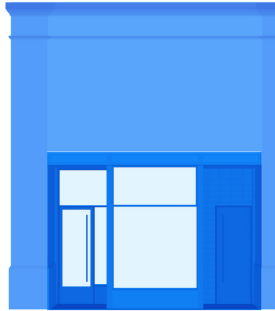

Level 3 storefront replacement Type A includes a full storefront removal and replacement in favor of a traditional storefront. Storefront assemblies can be comprised of wood or metal, and shall be constructed with a heritage style detailing and color palette. All paint selections shall be pulled from approved list of Pantone colors. All paint types shall be selected from the basis of design products that match the existing substrate material: masonry, metal or wood.

RECOMMENDATIONS

RESTORATION

Any existing historic details should attempt to be restored to original condition as part of any new work.

HISTORIC ELEMENTS

Historic elements are encouraged in the following:

Cornices - horizontal projecting components that crown an architectural element

Piers – exterior vertical members placed at intervals along a wall that separate openings

Transoms – glazed area above storefront panels

Awnings – metal frame clad with fabric above or within an opening

REQ DRAWINGS

You must submit a full drawing package for review. Drawings should include an exterior elevation, sections, and details.

HISTORIC ELEMENTS



DRAWING / DIAGRAM

EXAMPLE

Required storefront details that must be submitted for review.

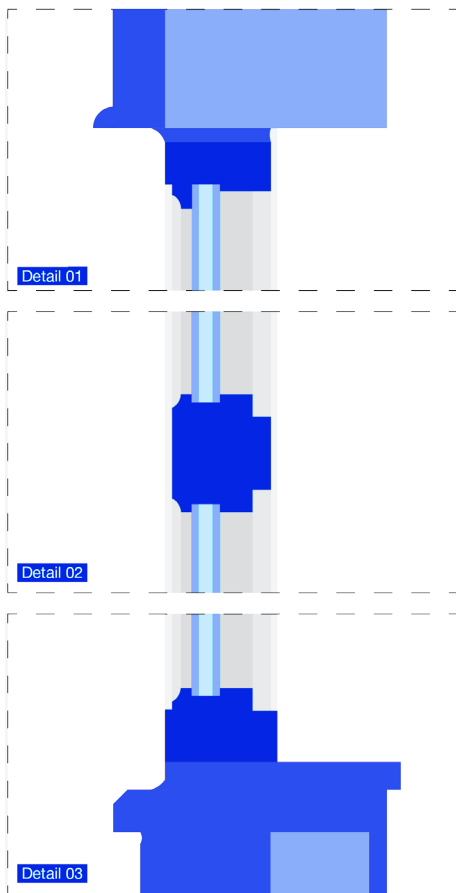

YOUR DESIGN

Submit your storefront design details for approval.



LEVEL 3 Type B

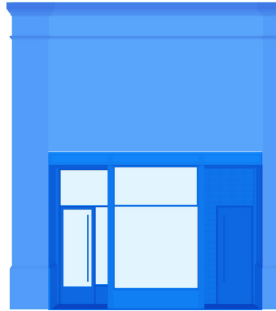

Level 3 storefront replacement Type B includes a full storefront removal and replacement in favor of a contemporary style storefront. Designed with a modern architecture style, the store facades window frames should have sleek lines and modern details. All paint selections shall be pulled from approved list of Pantone colors.

RECOMMENDATIONS

STYLE	Modern / contemporary
STOREFRONT FRAMES	Sleek horizontal and vertical lines
DETAILS	Minimize shapes and rounded details Minimize ornamentation
MATERIALS	Steel, iron, wood, or concrete
REQ DRAWINGS	You must submit a full drawing package for review. Drawings should include an exterior elevation, sections, and details.

EXAMPLES



MODERN COLOURS
MINIMAL DETAILS



FLAT PANELS
WITH METAL ACCENTS



FLAT PANEL BLENDS
WITH FACADE



FLAT PANEL
STOREFRONT

EXAMPLE

Required storefront details that must be submitted for review.

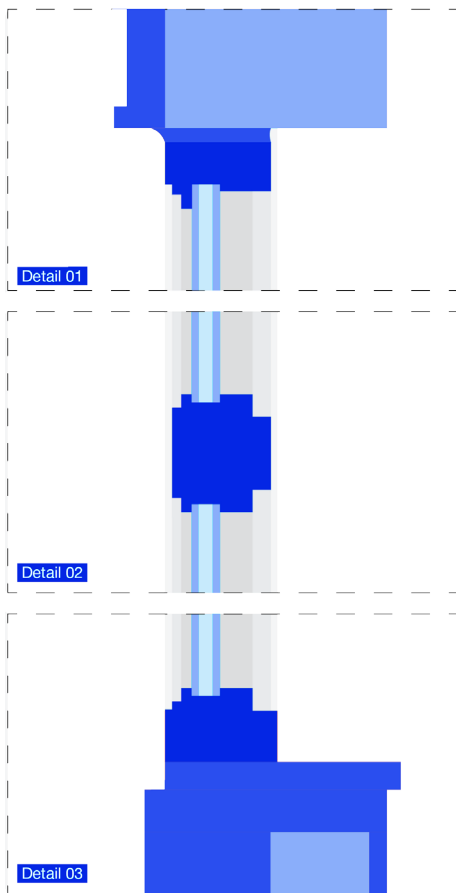

YOUR DESIGN

Submit your storefront design details for approval.



STEP BY STEP



EVALUATE EXISTING SUBSTRATE

A professional must evaluate the existing substrate and storefront to verify a storefront removal is possible and will not damage the existing structure.

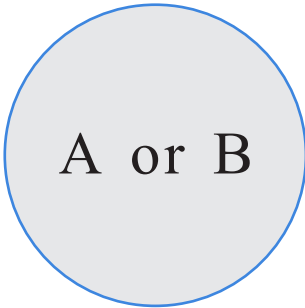

SELECT YOUR STYLE

Choose between historic and contemporary storefront replacements.

** If your building has existing historic detailing, we encourage you to select Type 3A.



SUBMIT DRAWING OF PROPOSED WORK / COLOR PALETTE

Submit an architectural drawing of the required storefront details, and new architectural elements, your proposed colour palette, and any new signage elements for approval by city authorities.



INSTALLATION

Begin demolition of existing storefront and prepare the rough opening. Begin installation of new approved storefront, architectural elements, and signage.

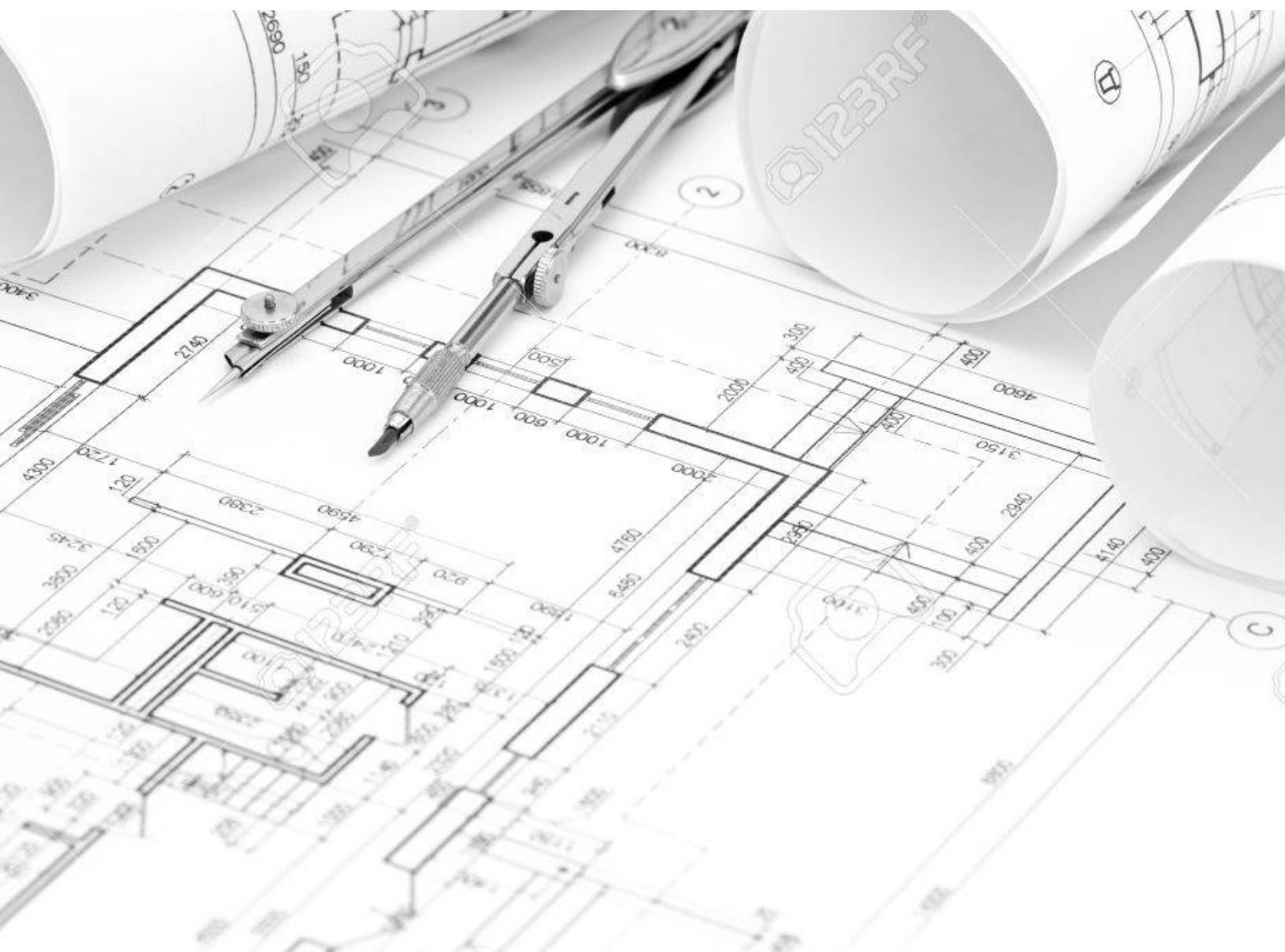

SPECIFICATIONS

COLOR PALETTES

BASE
COLOR

DARK TONES

MID TONES



TEXT/
LOGO
COLOR

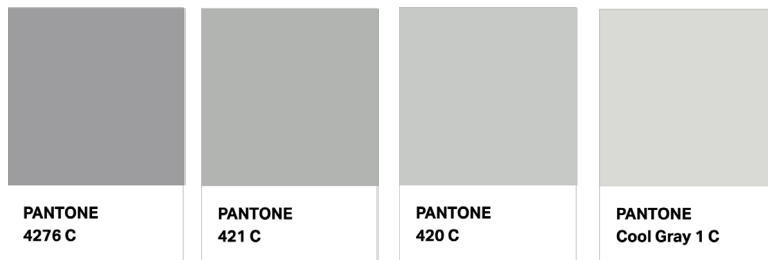

METAL
FINISHES



COLOR PALETTES

LIGHT TONES

BASE
COLOR

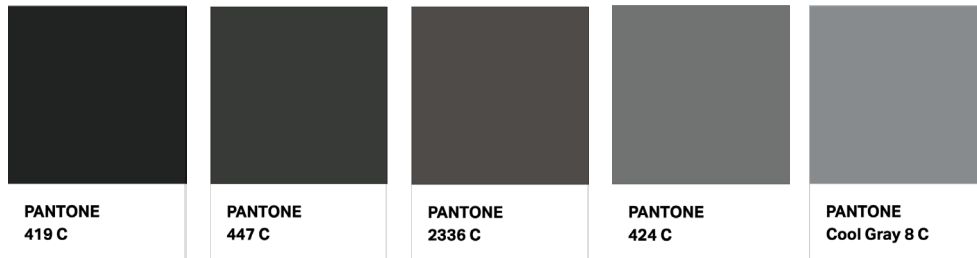
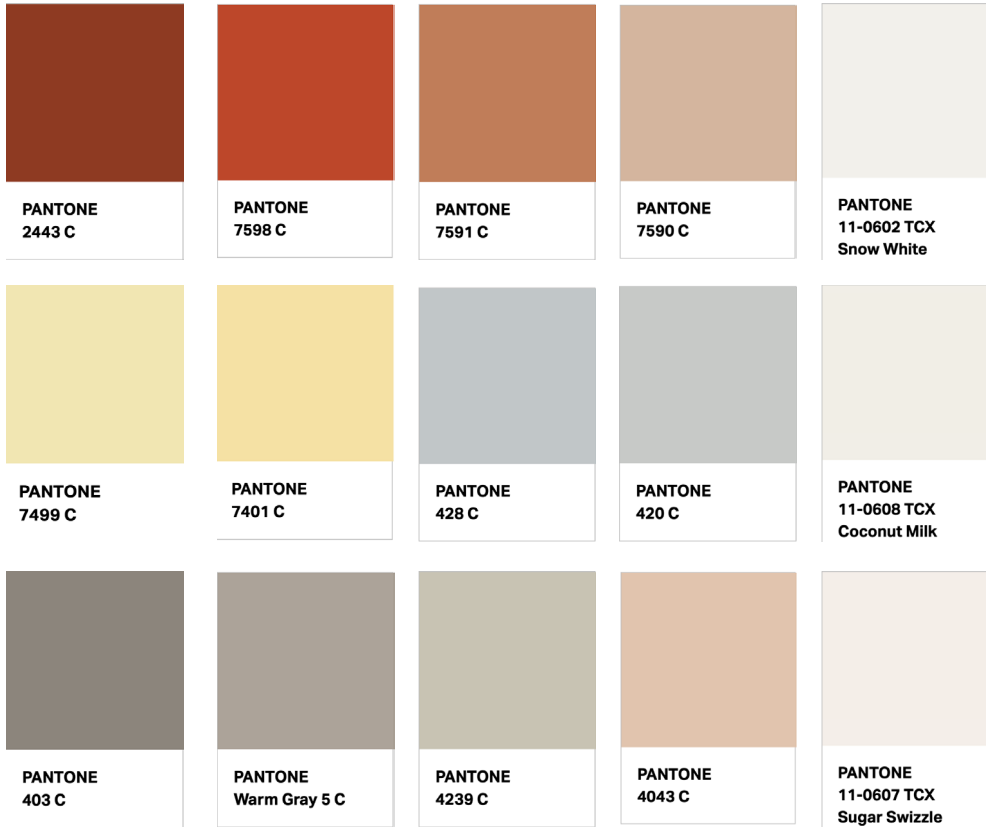

TEXT/
LOGO
COLOR



METAL
FINISHES

RECOMMENDED COLOR PALETTES

The following color combinations are recommended selections for facade, storefront, and signage that may be used without further approvals by the authorities. Refer to the example guide below for a guide of which colors correspond to which building elements. Custom combinations may also be proposed, but must be selected from the Color Palette on the preceding pages.

EXAMPLE

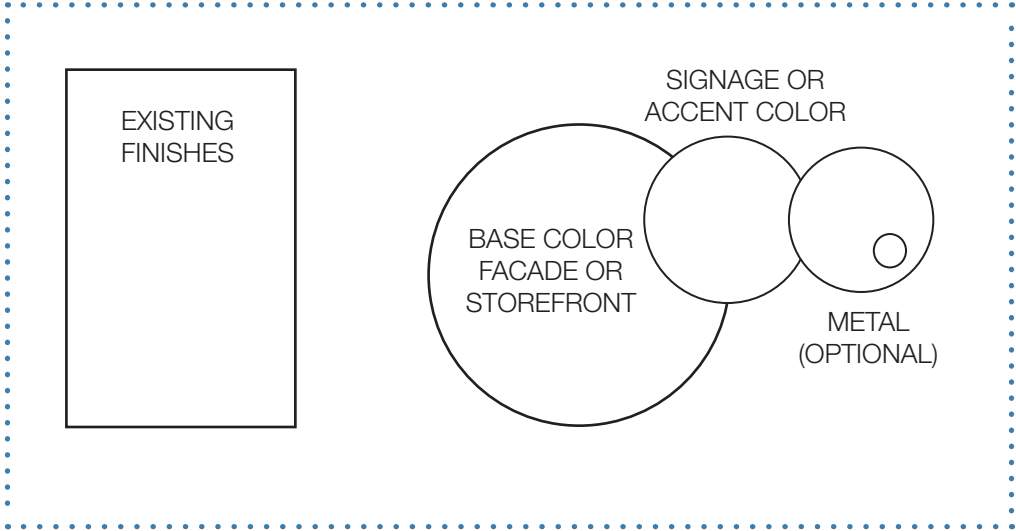



EXISTING BRICK

WARM GRAY
5C

BLACKENED
BRASS

PANTONE COLOUR
4239 C

420 C

SATIN
NICKEL

PANTONE COLOUR
7762 C

2336 C

MATTE
BLACK

PANTONE COLOUR
428 C

COOL
GREY 1C

VINTAGE
BRASS

PANTONE COLOUR
5463 C

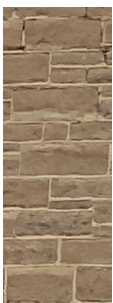

EXISTING
MASONRY

COOL
GREY 1C

VINTAGE
BRASS

PANTONE COLOUR
2379 C

11-0608
TCX

SATIN
NICKEL

PANTONE COLOUR
4975 C



EXISTING BRICK

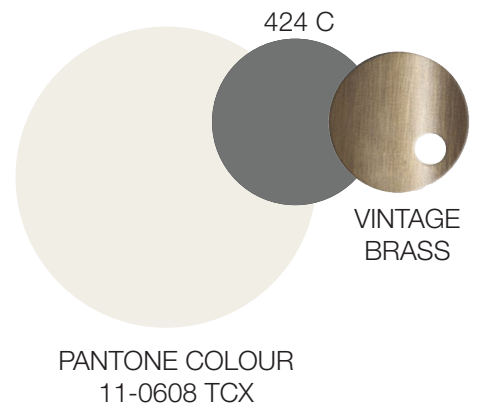
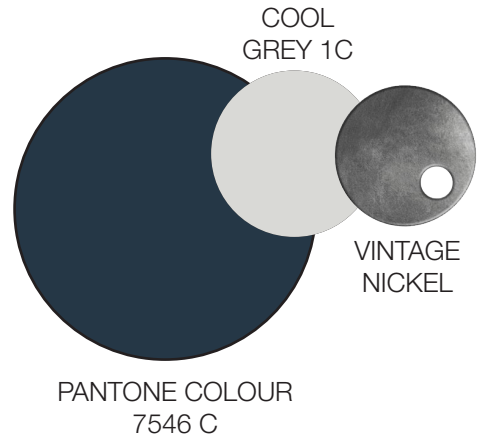
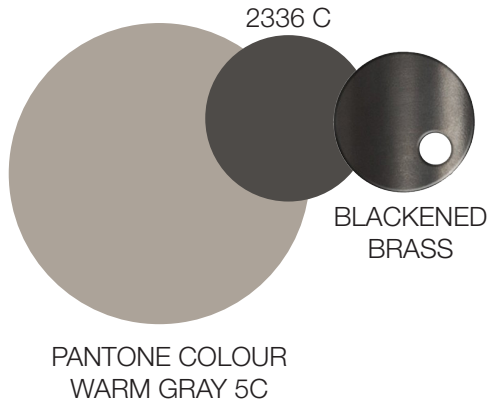

NO EXISTING MATERIALS

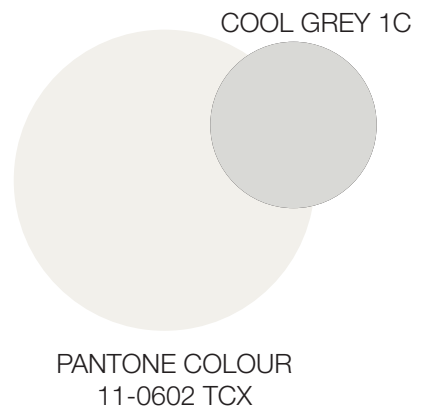
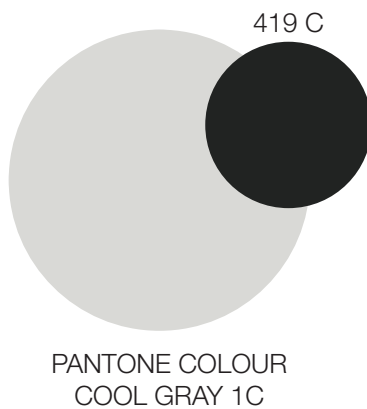

PAINT SPECIFICATIONS

PRIMER							
MASONRY	<table border="1" style="width: 100%; border-collapse: collapse;"> <tr> <td style="width: 50%; padding: 5px;">CONCRETE BLOCK</td> <td style="width: 50%; padding: 5px;">ULTRA SPEC 609 (IF AVAILABLE)</td> </tr> <tr> <td style="padding: 5px;">BRICK</td> <td style="padding: 5px;">OR</td> </tr> <tr> <td style="padding: 5px;">STUCCO</td> <td style="padding: 5px;">ULTRA SPEC 359 - FLAT</td> </tr> </table>	CONCRETE BLOCK	ULTRA SPEC 609 (IF AVAILABLE)	BRICK	OR	STUCCO	ULTRA SPEC 359 - FLAT
CONCRETE BLOCK	ULTRA SPEC 609 (IF AVAILABLE)						
BRICK	OR						
STUCCO	ULTRA SPEC 359 - FLAT						
METALS	<table border="1" style="width: 100%; border-collapse: collapse;"> <tr> <td style="width: 50%; padding: 5px;">STRUCTURAL STEEL (NOT RATED PAINT)</td> <td style="width: 50%; padding: 5px;">ULTRA SPEC HP, ACRYLIC METAL PRIMER, FP-04</td> </tr> <tr> <td style="padding: 5px;">DECORATIVE METALS</td> <td></td> </tr> </table>	STRUCTURAL STEEL (NOT RATED PAINT)	ULTRA SPEC HP, ACRYLIC METAL PRIMER, FP-04	DECORATIVE METALS			
	STRUCTURAL STEEL (NOT RATED PAINT)	ULTRA SPEC HP, ACRYLIC METAL PRIMER, FP-04					
DECORATIVE METALS							
	<table border="1" style="width: 100%; border-collapse: collapse;"> <tr> <td style="width: 50%; padding: 5px;">EXISTING ANODIZED ALUMINUM</td> <td style="width: 50%; padding: 5px;">V-110 ACRYLIC METAL PRIMER</td> </tr> </table>	EXISTING ANODIZED ALUMINUM	V-110 ACRYLIC METAL PRIMER				
EXISTING ANODIZED ALUMINUM	V-110 ACRYLIC METAL PRIMER						
WOOD	<table border="1" style="width: 100%; border-collapse: collapse;"> <tr> <td style="width: 50%; padding: 5px;">PREVIOUSLY STAIN, PAINTED OR SEALED</td> <td style="width: 50%; padding: 5px;">IF NEEDED, USE FRESH START ALL-PURPOSE OIL BASED PRIMER (C-085) OR</td> </tr> <tr> <td></td> <td style="padding: 5px;">OR</td> </tr> <tr> <td></td> <td style="padding: 5px;">FRESH START EXTERIOR WOOD PRIMER (F-094)</td> </tr> </table>	PREVIOUSLY STAIN, PAINTED OR SEALED	IF NEEDED, USE FRESH START ALL-PURPOSE OIL BASED PRIMER (C-085) OR		OR		FRESH START EXTERIOR WOOD PRIMER (F-094)
	PREVIOUSLY STAIN, PAINTED OR SEALED	IF NEEDED, USE FRESH START ALL-PURPOSE OIL BASED PRIMER (C-085) OR					
	OR						
	FRESH START EXTERIOR WOOD PRIMER (F-094)						
	<table border="1" style="width: 100%; border-collapse: collapse;"> <tr> <td style="width: 50%; padding: 5px;">NEW OR WEATHERED</td> <td style="width: 50%; padding: 5px;">NOT REQUIRED IN MOST CASES</td> </tr> </table>	NEW OR WEATHERED	NOT REQUIRED IN MOST CASES				
NEW OR WEATHERED	NOT REQUIRED IN MOST CASES						

PAINT SPECIFICATIONS

FINISH COAT

OPTIONAL

ULTRA SPEC 359 - FLAT
OR
ULTRA SPEC 360 - LOW LUSTER

ULTRA SPEC K-571 BLOCK FILLER
** IF NEEDED**

ULTRA SPEC HP, DTM ACRYLIC
GLOSS ENAMEL, FP-28
OR
ULTRA SPEC HP, DTM ACRYLIC SEMI-
GLOSS, FP-29

ARBORCOAT, EXTERIOR WATERBORNE STAIN
SOLID K-640
** SELF PRIMING ON MOST SURFACES**

ARBORCOAT, EXTERIOR WATERBORNE STAIN
SOLID K-640
** SELF PRIMING ON MOST SURFACES**

BASIS OF DESIGN

Benjamin Moore Paints

Refer to Appendix for Technical
Data sheets

End of Document